

STRUCTURAL PRINCIPLE

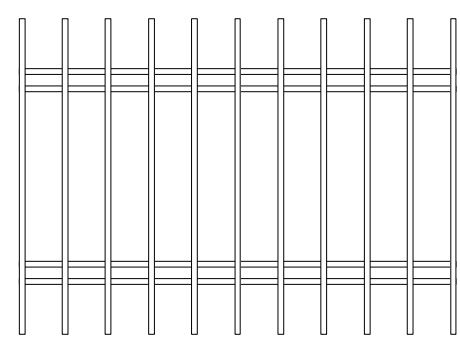

self supported floor

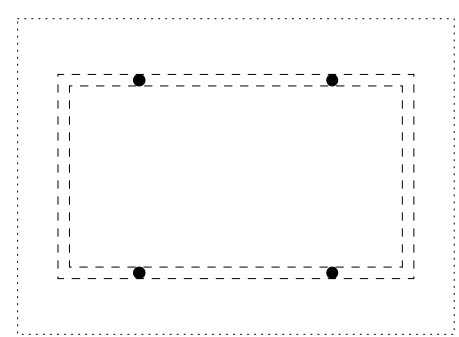

columns and beams

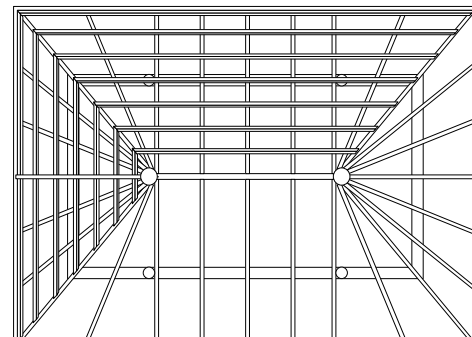

self supported roof

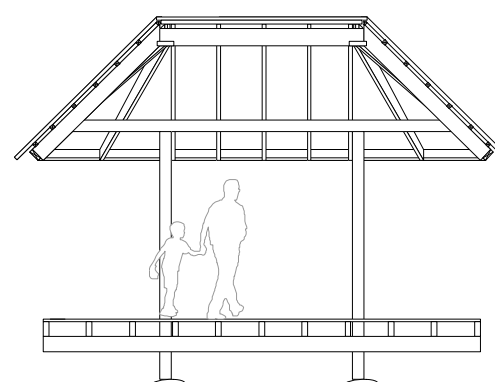

structural principle: stone - column - floor - roof

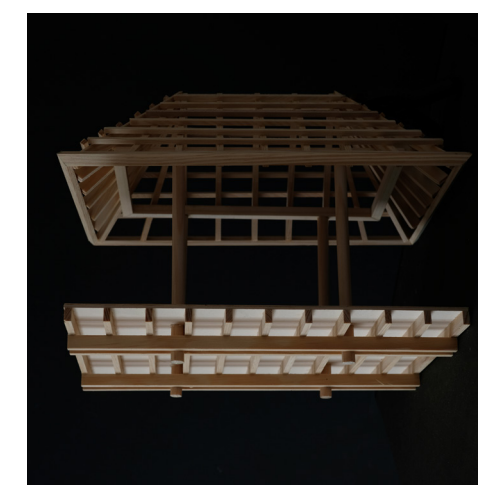

CAFE KIOSK

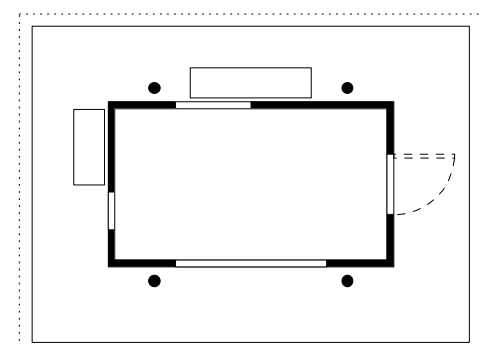

floorplan (24m2)

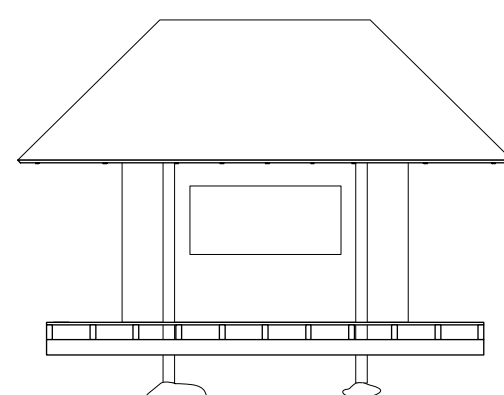

elevations

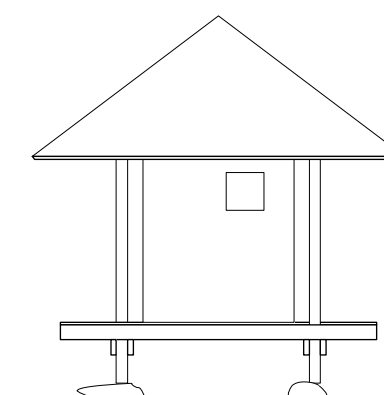
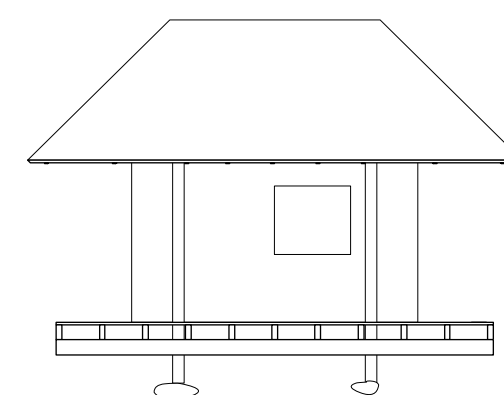
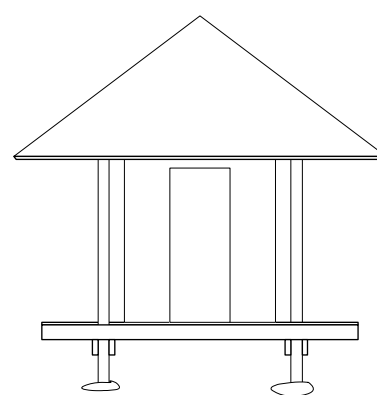

CAFE

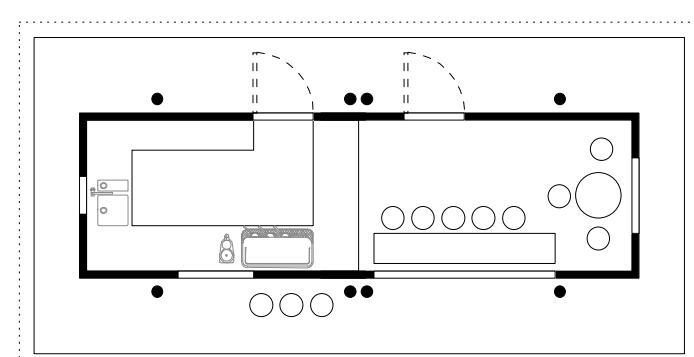

floorplan (36m2)

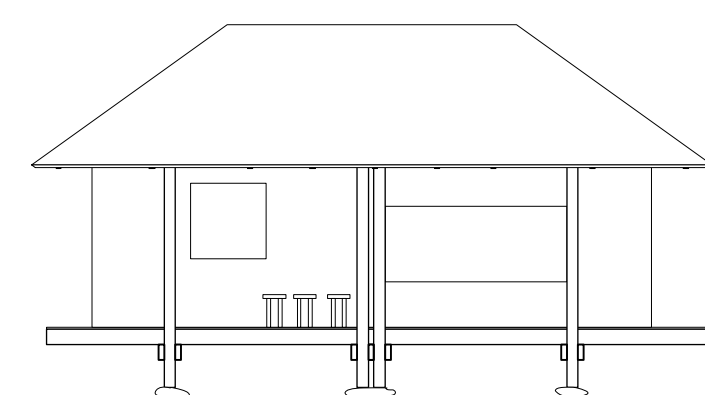

elevations

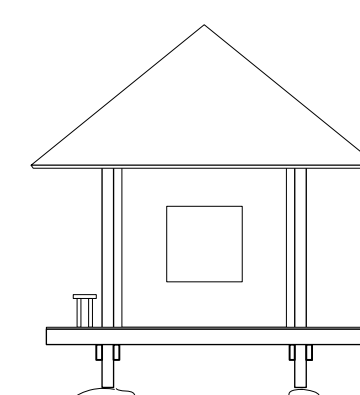

COOKING SHELTER LARGE

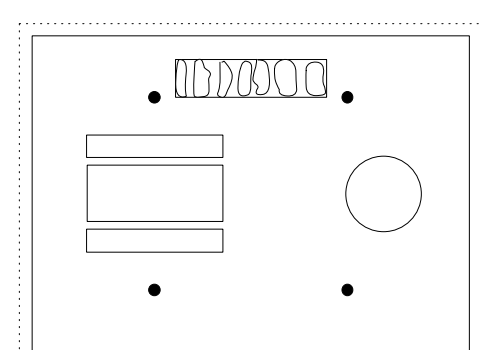

floorplan (24m2)

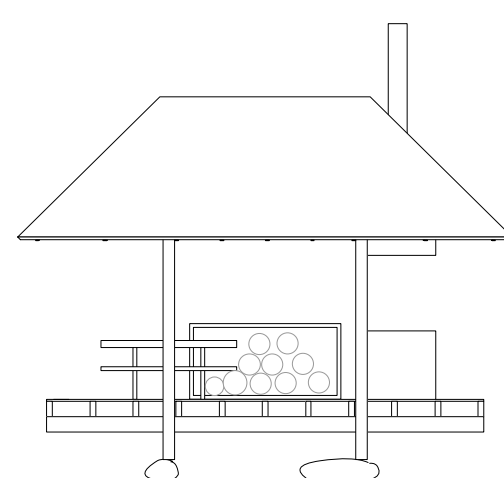

elevations

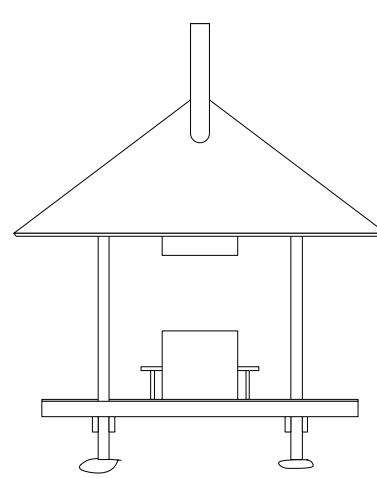

COOKING SHELTER SMALL

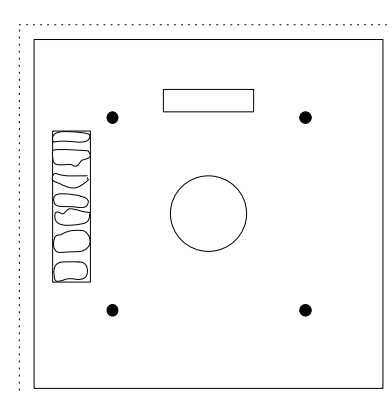

floorplan (20m2)

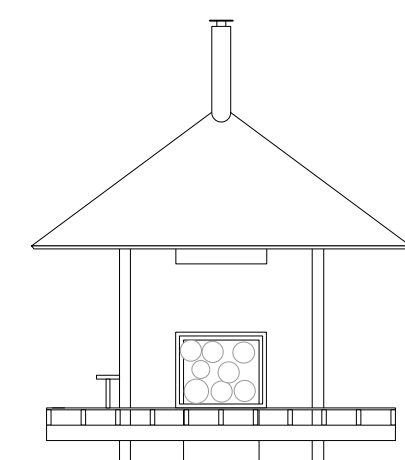

elevations

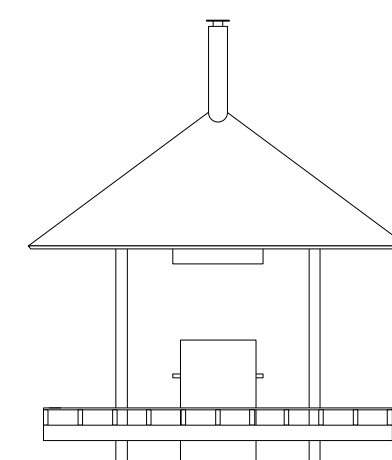

SMOKE / SMALL SAUNA

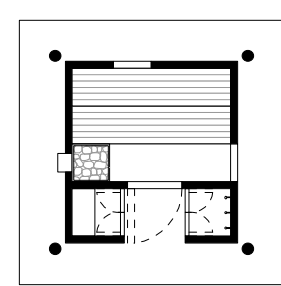

floorplan (12m2)

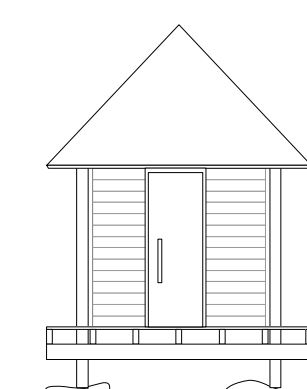

elevations

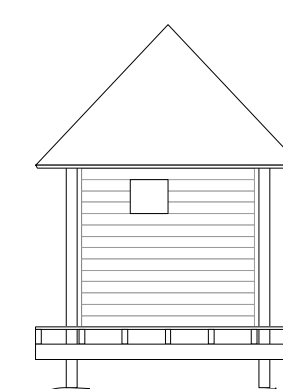
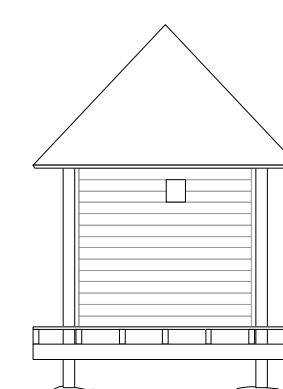
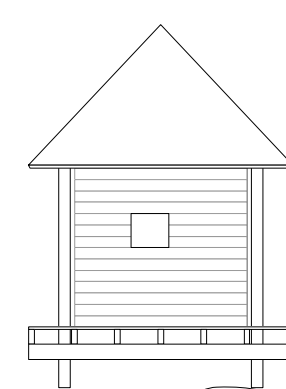

PUBLIC SAUNA (MAN - WOMAN)

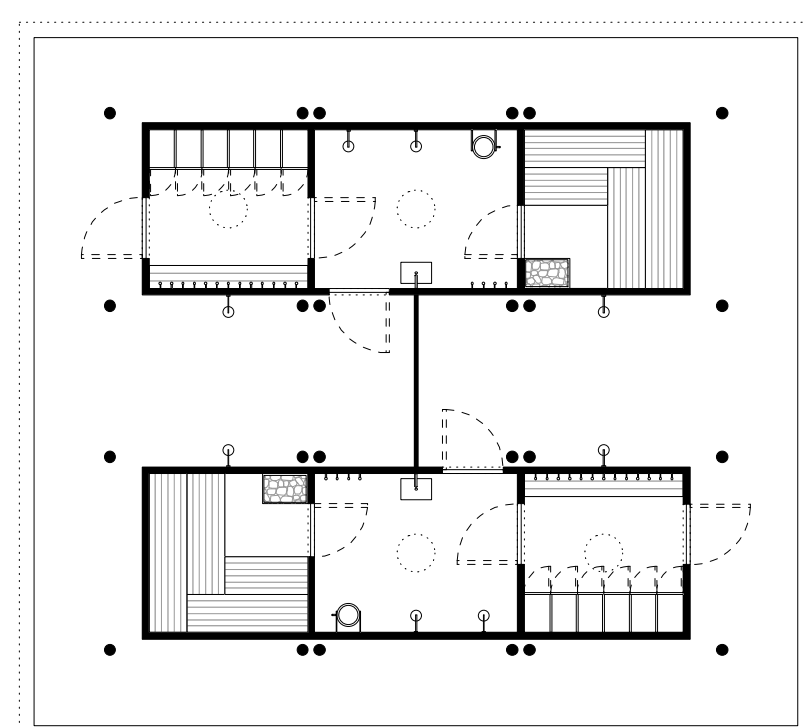

floorplan (90m2)

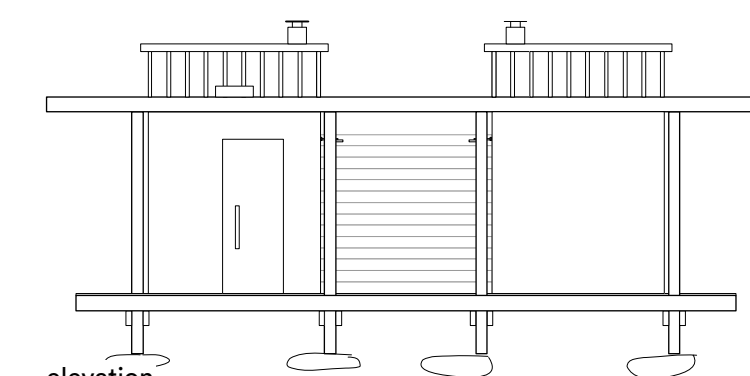

elevation

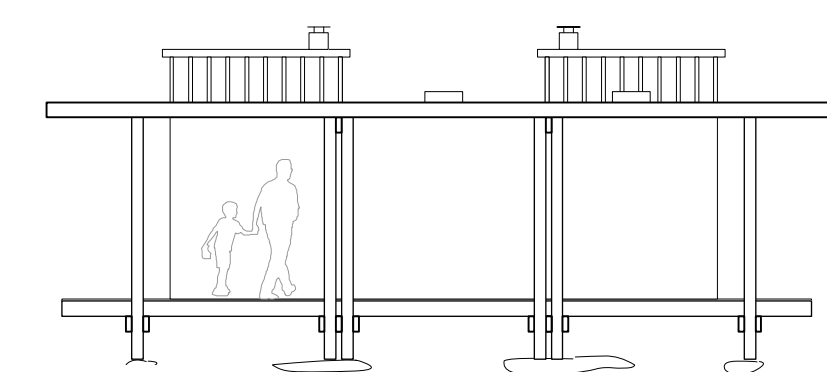

elevation

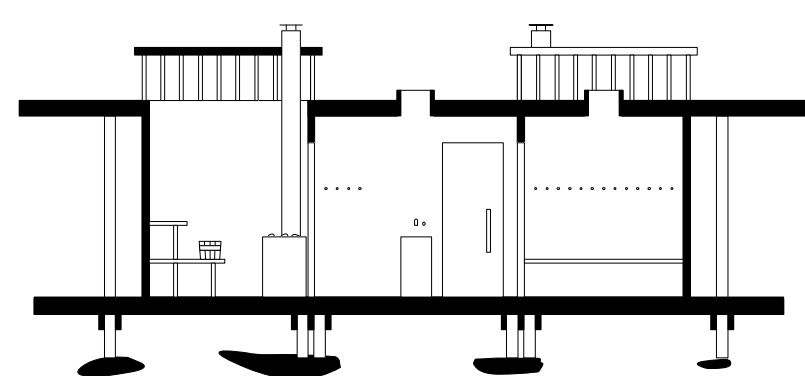

section

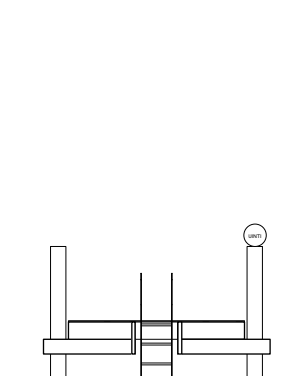

SWIMMING PIER

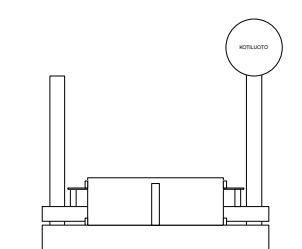
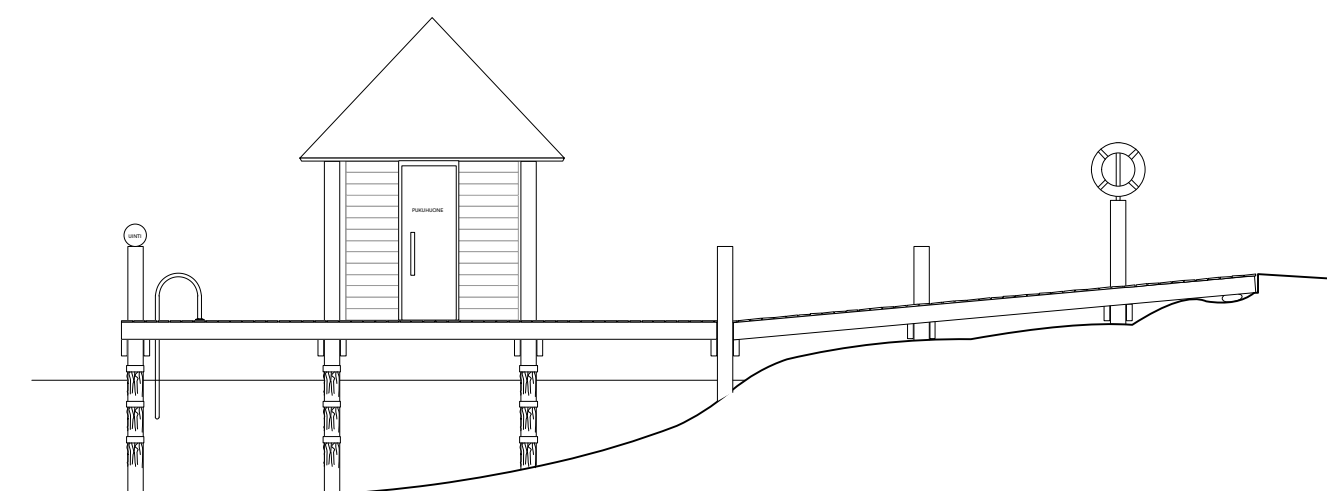

RECREATIONAL BOAT PONTOON

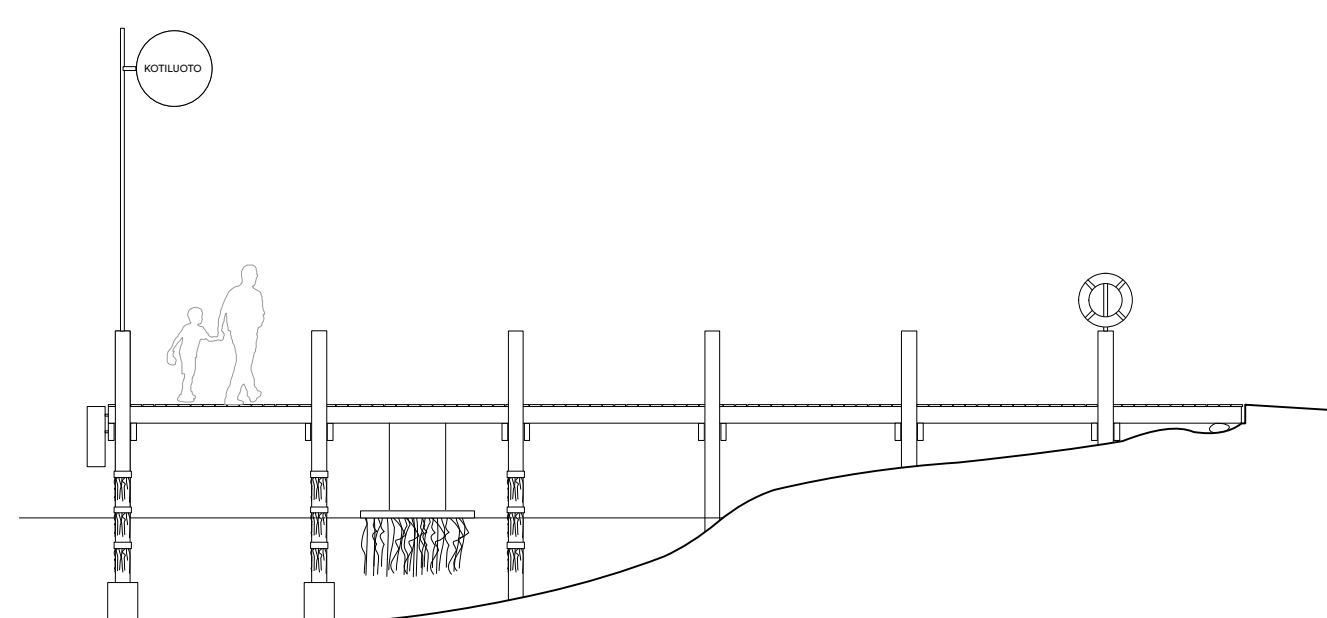
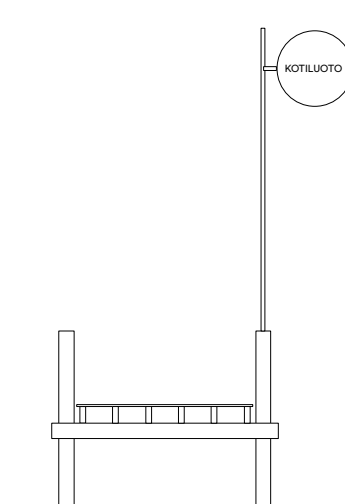

WATERBUS JETTY